

PC

MATERIALS

Head:
Cast iron

Bowl:
Steel

Bypass valve:
NBR Nitrile
(FKM - on request fluoroelastomer)

Seals:
NBR Nitrile
(FKM - on request fluoroelastomer)

Indicator housing:
Brass

PRESSURE (ISO 10771-1:2002)

Max. working: 31,5 MPa (315 bar)

Test: 47 MPa (470 bar)

Bursting: 95 MPa (950 bar)

Collapse, differential
for the filter element (ISO 2941):
series standard 2 MPa (20 bar)
serie H+ 21 MPa (210 bar)

BYPASS VALVE

Setting:
600 kPa (6 bar) \pm 10%

WORKING TEMPERATURE

From -25° to +110° C

COMPATIBILITY (ISO 2943)

Full with fluids: HH-HL-HM-HV-HTG
(according to ISO 6743/4)
For fluids different than the above
mentioned, please contact our Sales
Department.

APPLICATION EXAMPLE



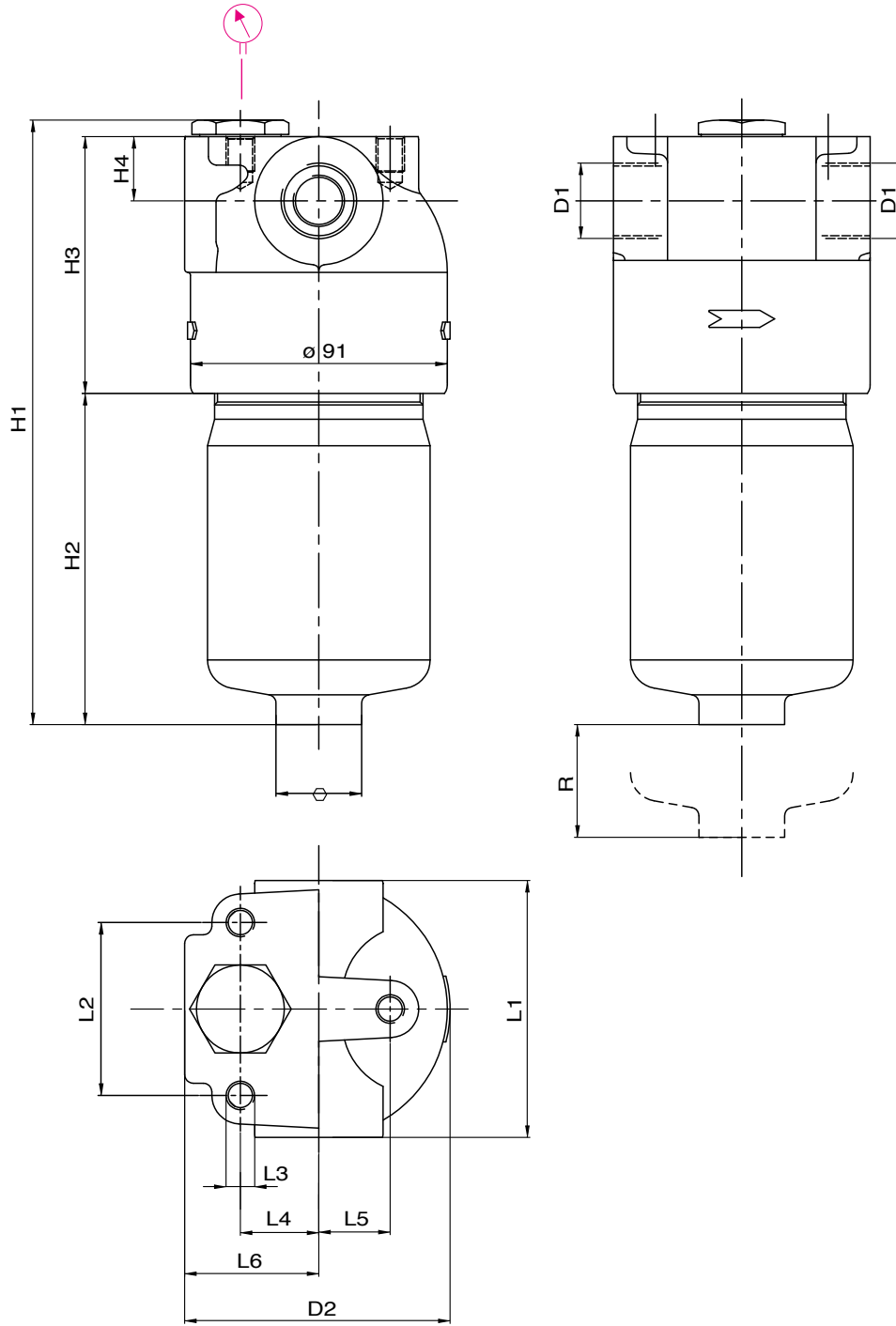

FILTER HOUSING													
	D1	D2	H1	H2	H3	H4	L1	L2	L3	L4	L5	R	kg
FPC21	1/2" - 3/4" - 1"	93	214	116	90	22,5	90	60,6	M10	27,5	25	100	4,3
FPC22	1/2" - 3/4" - 1"	93	305	207	90	22,5	90	60,6	M10	27,5	25	100	5,9

		TYPE			
		F = FILTER COMPLETE	F	F	
		B = FILTER HOUSING	B	B	ELEMENT E
P	C	FAMILY, SIZE & LENGTH			P B
			21	22	FAMILY SIZE & LENGTH
B		PORT TYPE			
		B = BSP - thread	B	B	
		PORT SIZE			
		04 = 1/2"	04	04	
		06 = 3/4"	06	06	
		08 = 1"	08	08	
		BYPASS VALVE			
		W = without	W	W	
		C = 600 kPa (6 bar)	C	C	
		SEALS			SEALS
		N = NBR Nitrile	N	N	N = NBR
		F = FKM Fluoroelastomer	F	F	F = FKM
		FILTER MEDIA			FILTER MEDIA
		FA = fiber 5 μm _e β>1.000 Δp 2MPa (20 bar)	FA	FA	FA = fib. 5μm _e 20 bar
		FB = fiber 7 μm _e β>1.000 Δp 2MPa (20 bar)	FB	FB	FB = fib. 7μm _e 20 bar
		FC = fiber 12 μm _e β>1.000 Δp 2MPa (20 bar)	FC	FC	FC = fib. 12μm _e 20 bar
		FD = fiber 21 μm _e β>1.000 Δp 2MPa (20 bar)	FD	FD	FD = fib. 21μm _e 20 bar
		HA = fiber 5 μm _e β>1.000 Δp 21MPa (210 bar)	HA	HA	HA = fib. 5μm _e 210 bar
		HB = fiber 7 μm _e β>1.000 Δp 21MPa (210 bar)	HB	HB	HB = fib. 7μm _e 210 bar
		HC = fiber 12 μm _e β>1.000 Δp 21MPa (210 bar)	HC	HC	HC = fib. 12μm _e 210 bar
		HD = fiber 21 μm _e β>1.000 Δp 21MPa (210 bar)	HD	HD	HD = fib. 21 μm _e 210 bar
		CC = cellulose 10 μm β>2 Δp 2MPa (20 bar)	CC	CC	CC = cel. 10 μm 20 bar
		CLOGGING INDICATORS			
		03 = port, plugged	03	03	When the filter is ordered with FKM seals, the first digit of the indicator code is a letter (please see page 182 - 183).
		5E = visual differential 500 kPa (5 bar)	5E	5E	
		5F = visual differential 800 kPa (8 bar)	5F	5F	
		6E = electrical differential 500 kPa (5 bar)	6E	6E	
		6F = electrical differential 800 kPa (8 bar)	6F	6F	
		7E = indicator 6E with LED	7E	7E	
		7F = indicator 6F with LED	7F	7F	
		T2 = elect. diff. 500 kPa (5 bar) with thermostat 30°C	T2	T2	
		T3 = elect. diff. 800 kPa (8 bar) with thermostat 30°C	T3	T3	
		ACCESSORIES			
X	X	XX = no accessory available	XX	XX	

FILTER ELEMENT

	A	B	C	kg media F+&C+	kg media H+	Area (cm ²)		
						Media F+	Media H+	Media C+
EPB21	52	23,5	115	0,25	0,40	975	975	780
EPB22	52	23,5	210	0,35	0,55	1.830	1.785	1.465

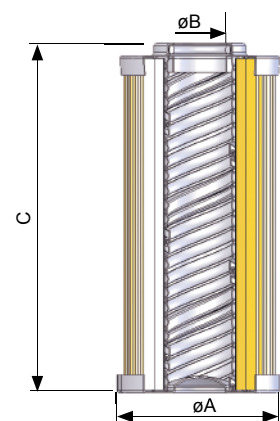

FLUID SPEED

when selecting the filter size, we suggest to consider also the max recommended fluid speed (in pressure lines normally $5 < v < 10$ m/s).

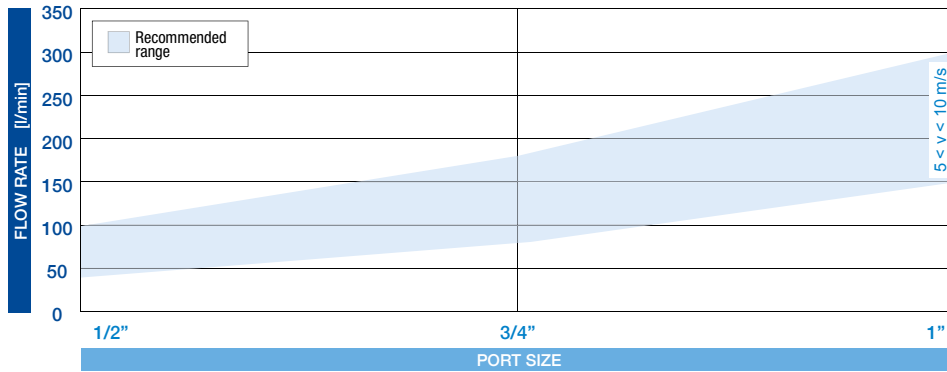

PRESSURE DROP CURVES (Δp)

The "Assembly Pressure Drop (Δp)" is obtained by adding the pressure drop values of the Filter Housing and of the Clean Filter Element corresponding to the considered Flow Rate and it must be lower than 120 kPa (1,2 bar).

FILTER HOUSING PRESSURE DROP
(mainly depending on the port size)

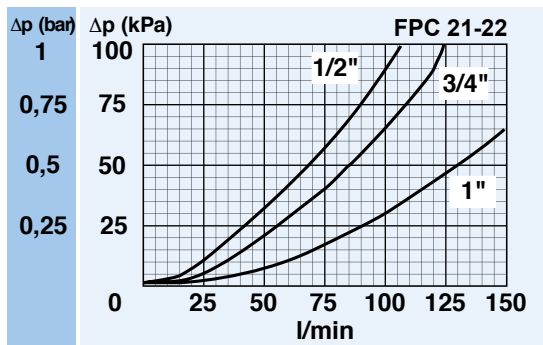

CLEAN FILTER ELEMENT PRESSURE DROP WITH F+ AND C+ MEDIA
(depending both on the internal diameter of the element and on the filter media)

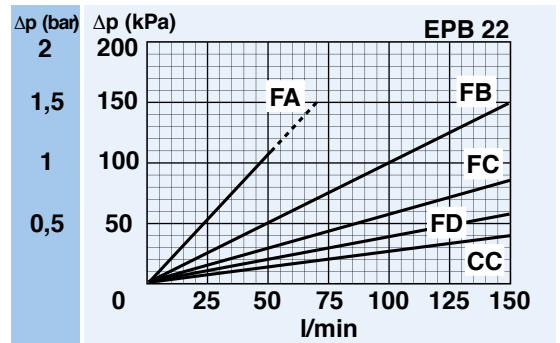
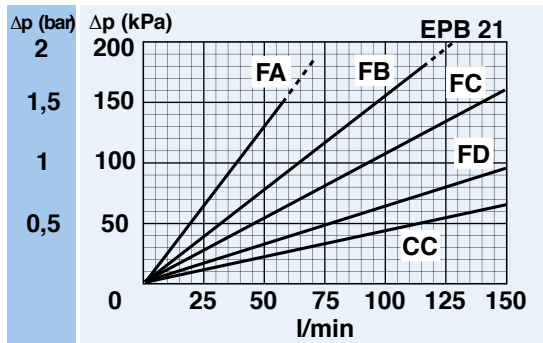

CLEAN FILTER ELEMENT PRESSURE DROP
(depending both on the internal diameter of the element and on the filter media)

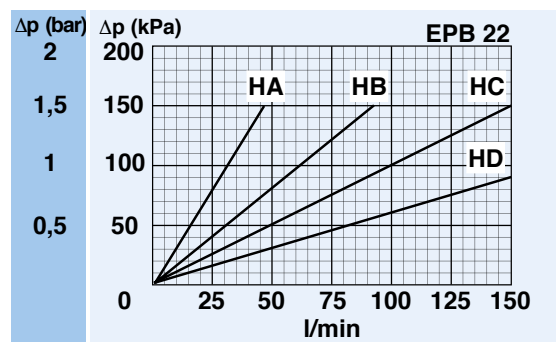
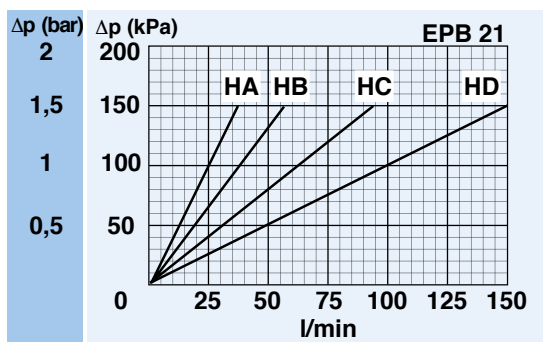

BYPASS VALVE PRESSURE DROP

When selecting the filter size, these curves must be taken into account if it is foreseen that any flow peak is to be absorbed by the bypass valve, it also must be of proper configuration to avoid pressure peaks. The valve pressure drop is directly proportional to fluid specific gravity.

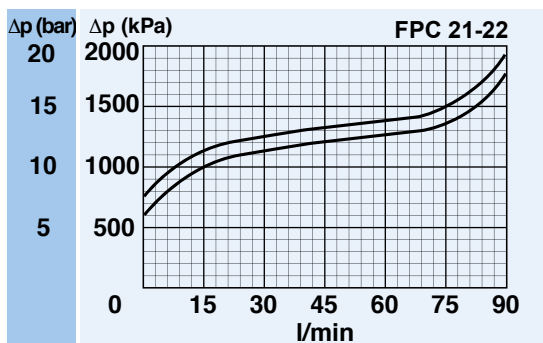

N.B. All the curves have been obtained with mineral oil having a kinematic viscosity 30 cSt and specific gravity 0,9 kg/dm³; for fluids with different features, please consider the factors described in the first part of this catalogue. All the curves are obtained from test done at the UFI HYDRAULIC DIVISION Laboratory, according to the specification ISO 3968:2005. In case of discrepancy, please check the contamination level, viscosity and features of the fluid in use.

CLOGGING INDICATOR

A visual or visual-electrical differential indicator is available as an option and allows monitoring of the element conditions, giving an exact indication of the right time to replace the element.

FILTER HOUSING

Head and bowl are made by high performance aluminium alloy ensuring the best fatigue resistance.

FILTER ELEMENT

The filter element is manufactured with filter medias selected in the UFI laboratory and mechanically supported to maintain the highest performance even at high differential pressures.

SEAL GUARANTEED

A perfect O-ring seal is always ensured as it is not dependent on the tightening torque applied to the bowl.

EASY MAINTENANCE

The hexagon end of the bowl allows for easy maintenance by using a simple hexagon wrench.

CLOGGING INDICATOR

For further technical informations and other options see page 182-183.

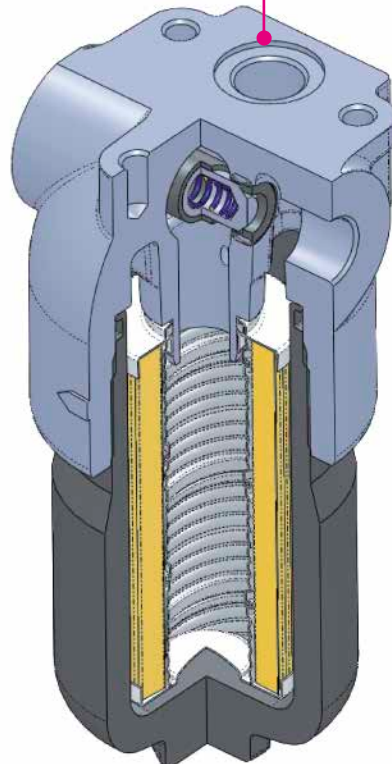

SPARE SEAL KIT

	NBR	FKM
FPC21	521.0003.2	521.0030.2
FPC22	521.0003.2	521.0030.2

FILTER HOUSING

B|P|B| |B| | | |X|X|

FILTER ELEMENT

E|P|B| | | |

CLOGGING INDICATOR

| |

SPARE PARTS ELEMENTS
 (For filling up see table
 "Ordering and option chart")



Is this datasheet the latest release? Please check on our website.

